

USA ILLUMINATION

1126 River Road, New Windsor, NY 12553
 Tel. 845-565-8500 Fax: 845-561-1130 email: info@usaillumination.com
 www.usaillumination.com

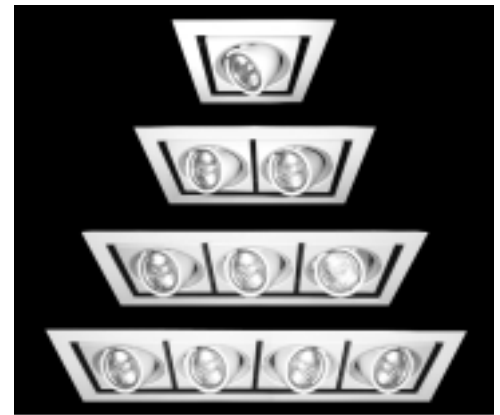

CATALOG NUMBER

4000 4010 4019 4030

FACETTE

LOW VOLTAGE MR16 RECESSED RETRACTABLE ADJUSTABLE

- 4000** - 1 Light Adjustable
- 4010** - 2 Light Adjustable
- 4019** - 3 Light Adjustable
- 4030** - 4 Light Adjustable

CEILING CUTOUT

- 5-3/8" x 5-3/8" - **4000**
- 5-3/8" x 9-3/8" - **4010**
- 5-3/8" x 13-5/8" - **4019**
- 5-3/8" X 17-5/8" - **4030**

MATERIAL

DIE CAST ALUMINUM
 STEEL

LAMP

- 1-50W MR16 - **4000**
- 2-50W MR16 - **4010**
- 3-50W MR16 - **4019**
- 4-50W MR16 - **4030**

LAMP HOLDER

DIE CAST ALUMINUM

HOUSING

FABRICATED OF
 DIE FORMED 20 GA.
 GALVANIZED STEEL.
 THRU-WIRE JUNCTION
 BOX, 3 IN 3 OUT AT
 MIN. 90°C, #12 AWG
 THRU BRANCH
 CIRCUIT WIRING.

FINISH

#	FLANGE	LAMP MODULE	HOUSING INTERIOR
10	WHITE	WHITE	BLACK
21	BLACK	BLACK	BLACK
28	MET GREY	MET GREY	BLACK
31	WHITE	BLACK	BLACK
38	MET GREY	BLACK	BLACK
40	WHITE	WHITE	WHITE

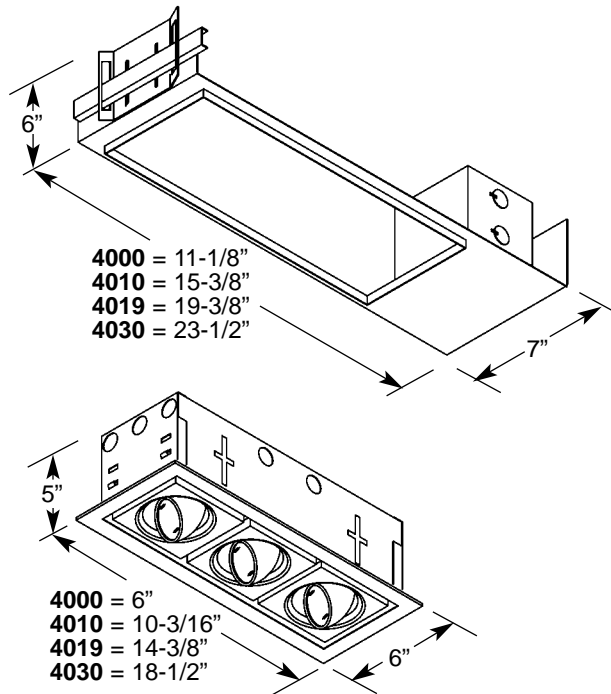

ADJUSTMENT

- TILT 60°
- ROTATION 356°
- LAMP MODULE POSITIONS
 FLUSH OR 1-1/4" REGRESSED

TRANSFORMER

INTEGRAL
SPECIFY: 120V OR 277V
 ELECTRONIC

ACCESSORIES

LENS OPTIONS

SOCKET

GU5.3
 PORCELAIN CONSTRUCTION
 WITH 18 GA., 250°C SF-2
 SLEEVED LEADS

MOUNTING OPTIONS

BUTTERFLY BRACKETS
 AND 16" NAILER BARS
 PROVIDED. CHANNEL
 MOUNTING BARS OR 24"
 NAILER BARS AVAILABLE
 AS ACCESSORIES.

LISTINGS

UL LISTED
 IBEW UNION MADE

ORDERING INFO.

CATALOG - FINISH - VOLTAGE

07/05

TRIM _____

PROJECT _____

TYPE _____

USA ILLUMINATION™

1126 River Road, New Windsor, NY 12553
 Tel. 845-565-8500 Fax: 845-561-1130 email: info@usaillumination.com
 www.usaillumination.com

BEAM DIAGRAMS

MR 16 HALOGEN LAMPS

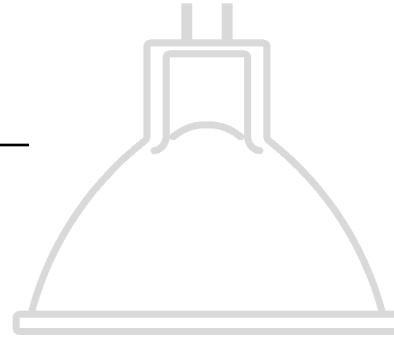

FOOTCANDLE CONES

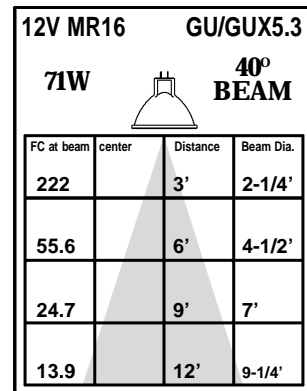
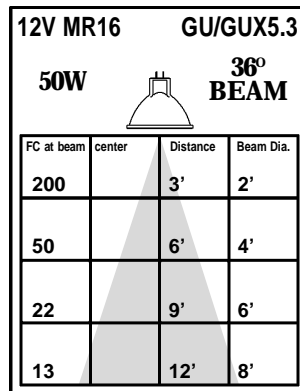
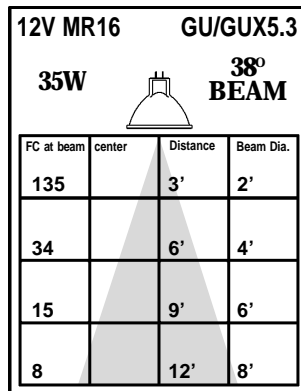
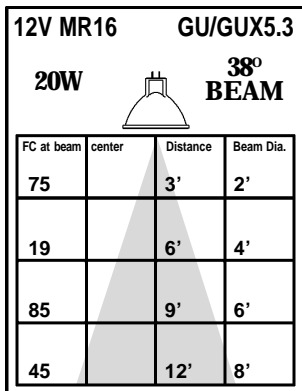
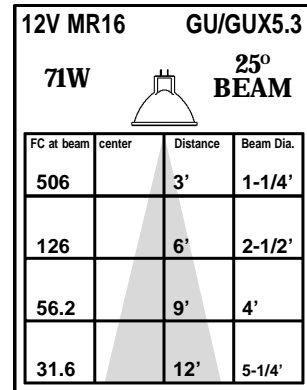
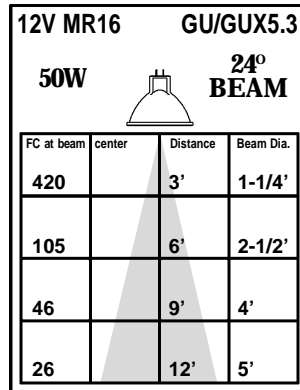
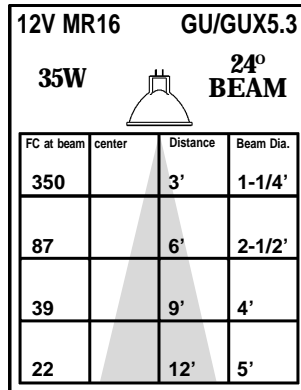
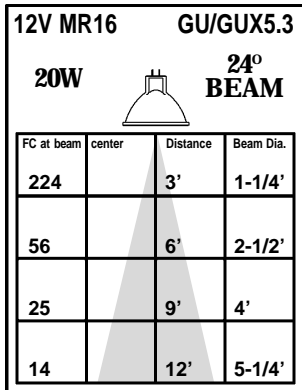
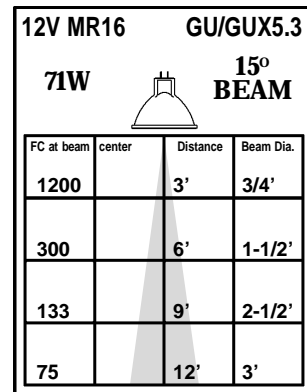
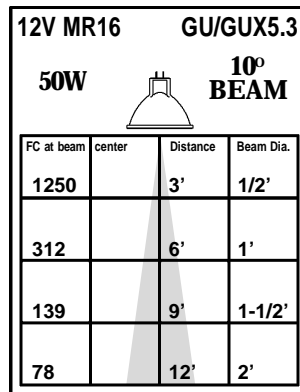
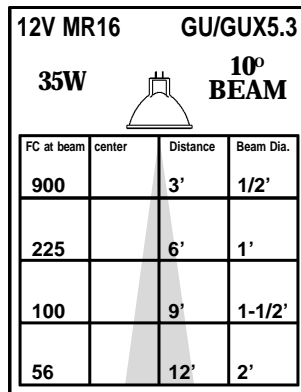
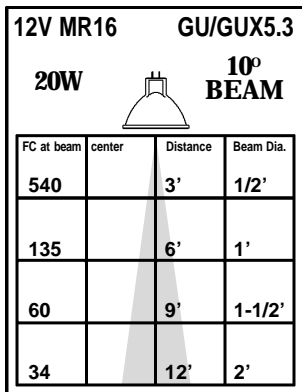

Actual results may vary.
 All dimensions and data subject to change.